

T-Wedge Instructions Dimensions

STEP 1

Clip wedges to fit desired angle.

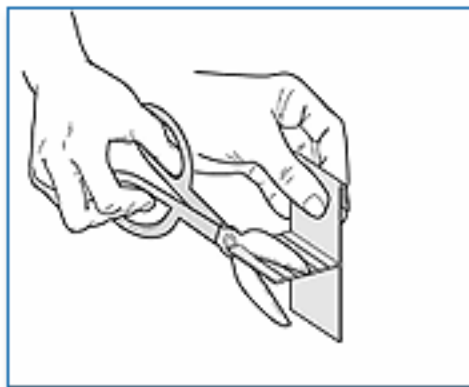

STEP 2

Squeeze hook portion of wedge to create snug fit.

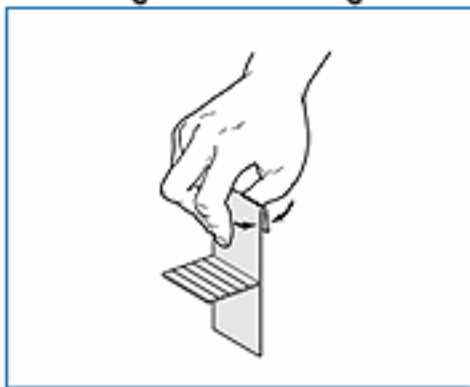

STEP 3

To attach, push wedge down firmly onto back of gutter every 3'.

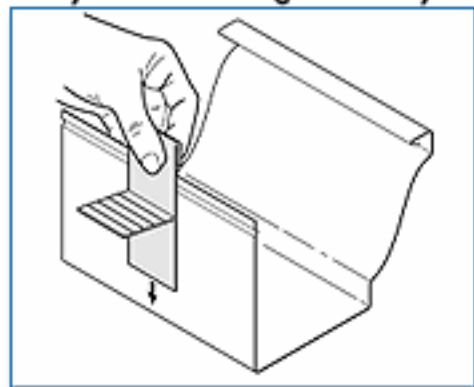

#4400

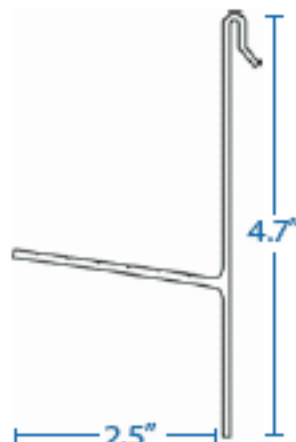

#4500

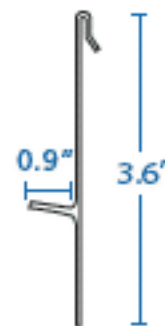

#4600

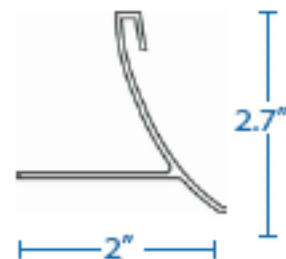

#4900

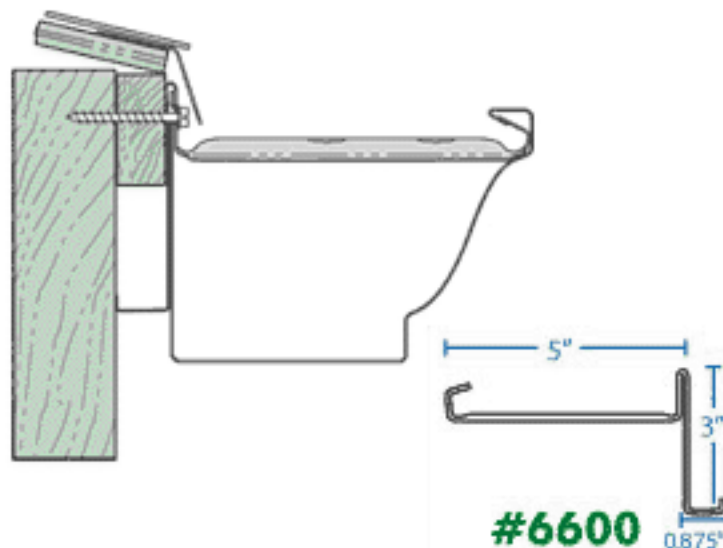

#6600

0.875"